

Making Letter Sized Proportion Rectangle from Square

© 1997 Sy Chen

Method I

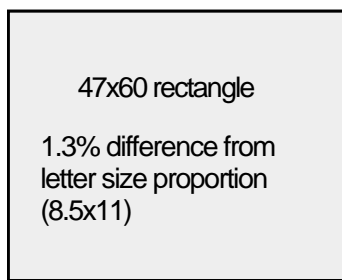
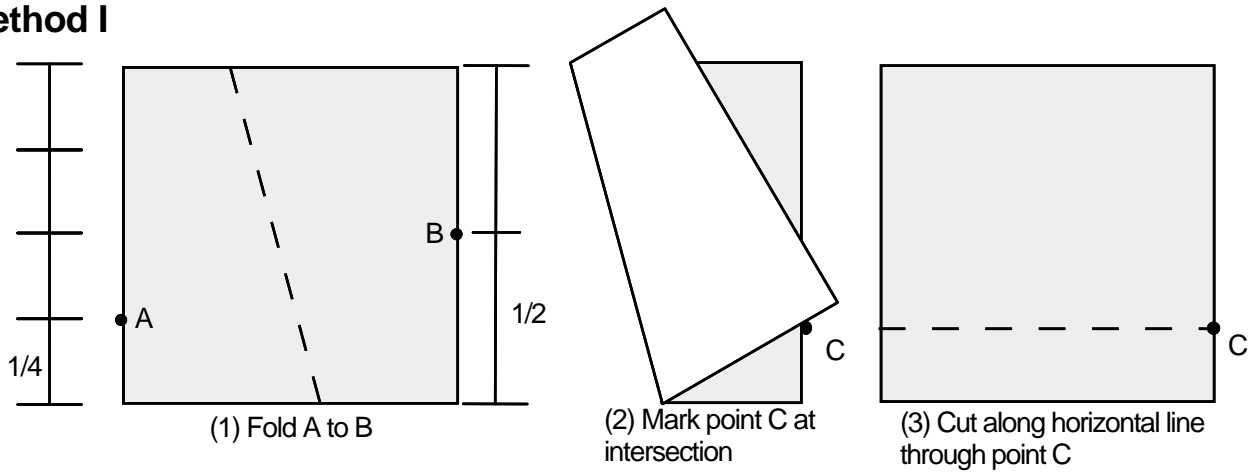

(4) Completed paper

Method II

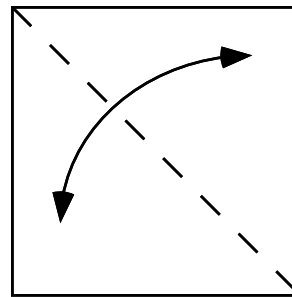

(1)

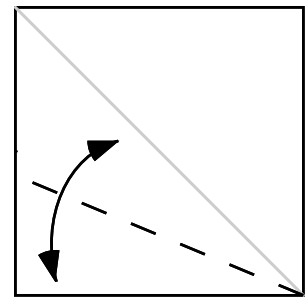

(2) Bisect angle again

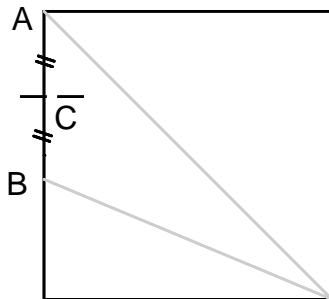

(3) Bisect AB to get C

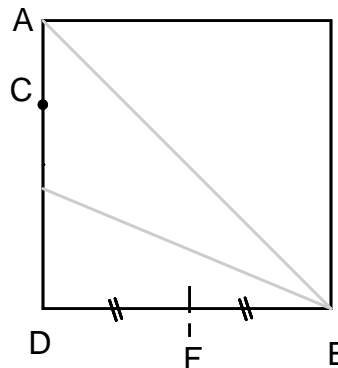

(4) Bisect DE to get F

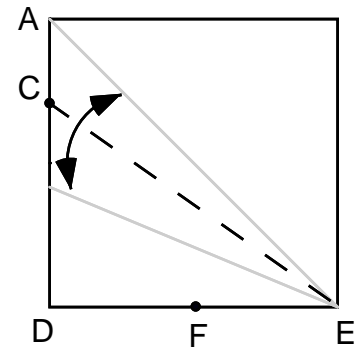

(5) Make crease passing C and E

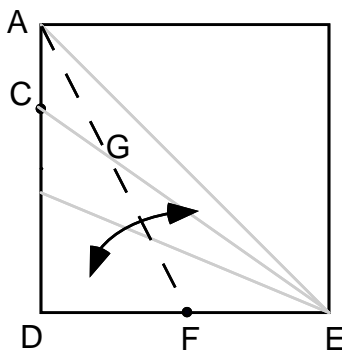

(6) Crease passing AF; G is the intersection of AF & CE

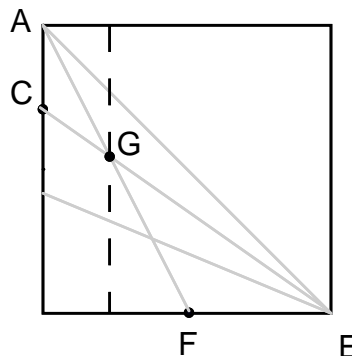

(7) Cut along vertical line through point G

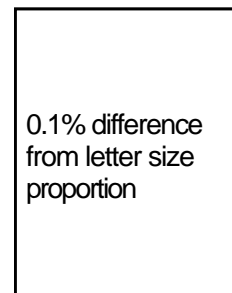

(8) Completed